

**XTERN SUMMIT ORTHOTIC
ORTHÈSE XTERN SUMMIT**

LARGE : 101100-SA-L
US SHOE SIZE / POINTURE
11US → 16 US Men



2022-09-06



PARTS LIST - XTERN SUMMIT ORTHOTIC KIT, SIZE LARGE			
Item	Qty	PRODUCT CODE	DESCRIPTION
A	1	201000-BA0-L	MAIN BRACE BODY ASSEMBLY, SIZE LARGE
B	1	201000-U00-L	FRONT SHOE SECTION «U» SHAPE, LARGE
C	1	201000-C00-ML	CALF SECTION, SIZE MEDIUM-LARGE
D	10	200000-L00-ML	LACE CLIP ATTACHMENT, SIZE MEDIUM-LARGE
E	1	501302-K00-ML	MOLDED CALF PAD + STRAP MEDIUM LARGE
F	3	700000-SET-007	SET SCREW 8-32 X 3/8" L. 18-8 STAINLESS STEEL
G	20	700000-ZZZ-001	TIE-WRAP BLACK 18 LBS/4" LONG
H	1	700000-HEX-003	HEX-L-KEY 5/64"

REQUIRED TOOLS (NOT INCLUDED)

OUTILS REQUIS (NON INCLUS)



DRILL BIT / MÈCHE
5/32" (4.00 mm)

For further technical information, visit or call: www.turbomedorthotics.com
Pour plus d'informations techniques, visiter ou appeler t: 1-888-778-8726

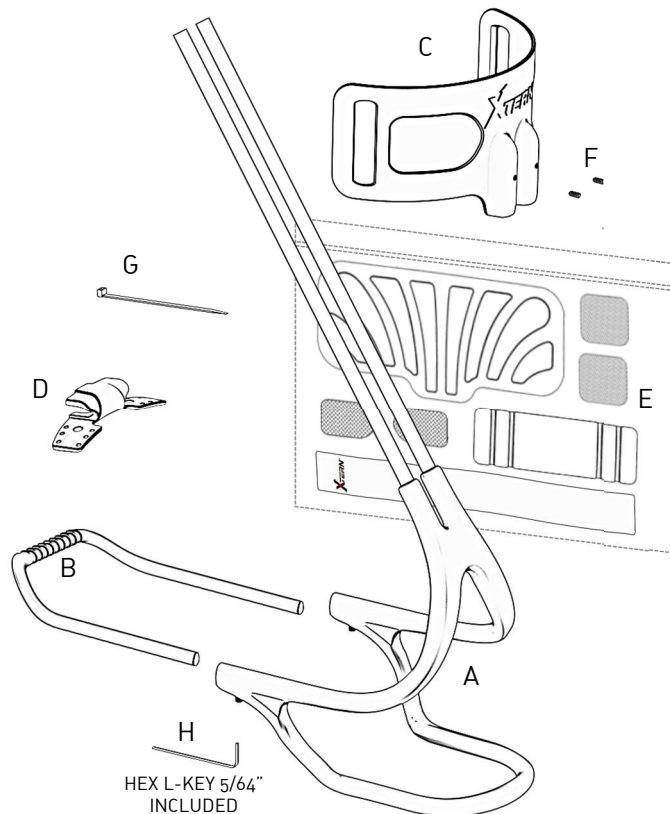

-1-

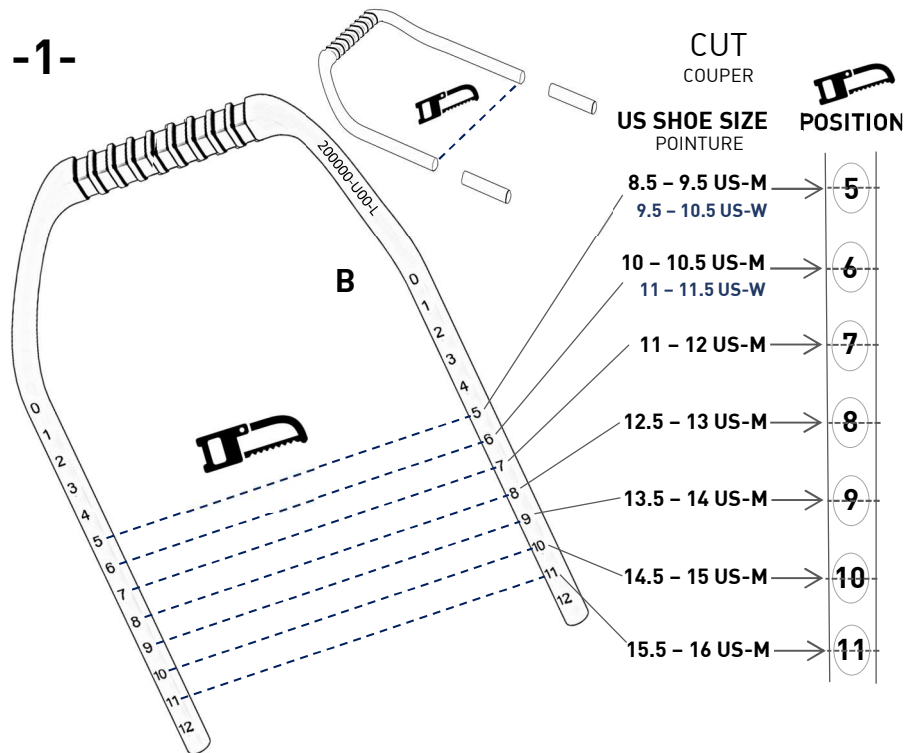

-2-

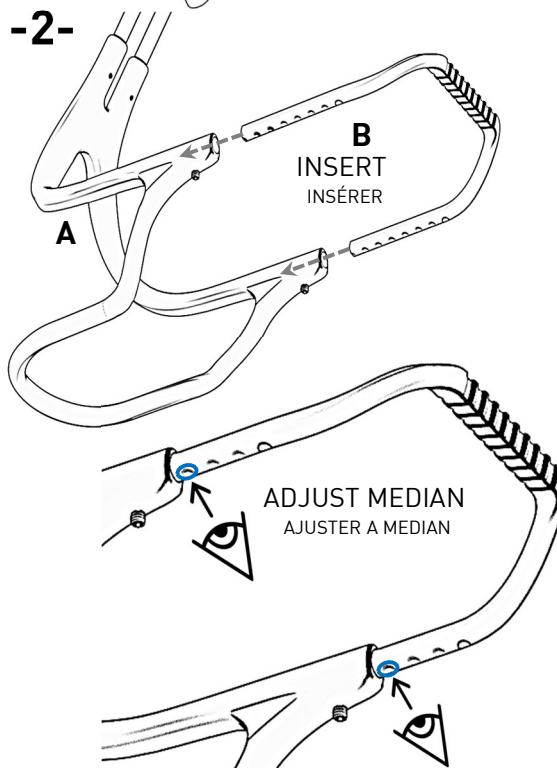

**ADJUST MEDIAN
AJUSTER MEDIAN**

POSITION	US SHOE SIZE POINTURE
1	8.5 - 9.5 US-M 9.5 - 10.5 US-W
2	10 - 10.5 US-M 11 - 11.5 US-W
3	11 - 12 US-M
4	12.5 - 13 US-M
5	13.5 - 14 US-M
6	14.5 - 15 US-M
7	15.5 - 16 US-M

-3-

**ADJUST MEDIAN
AJUSTER A MEDIAN**

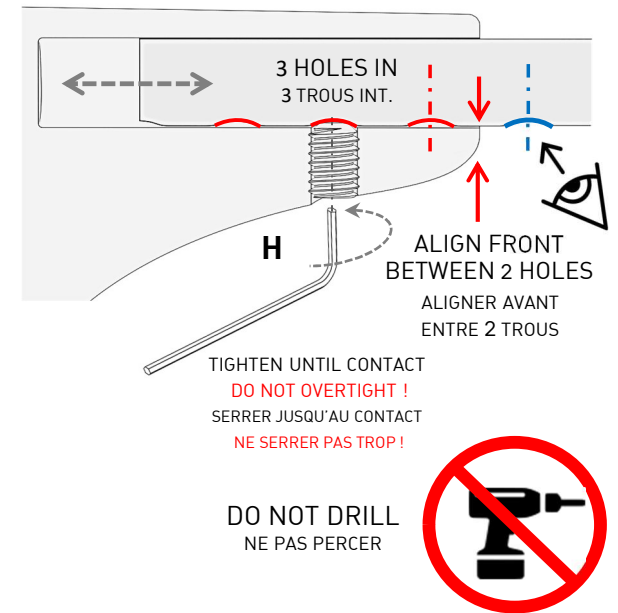

-4-

**LENGTH ADJUSTABLE
LONGUEUR AJUSTABLE**

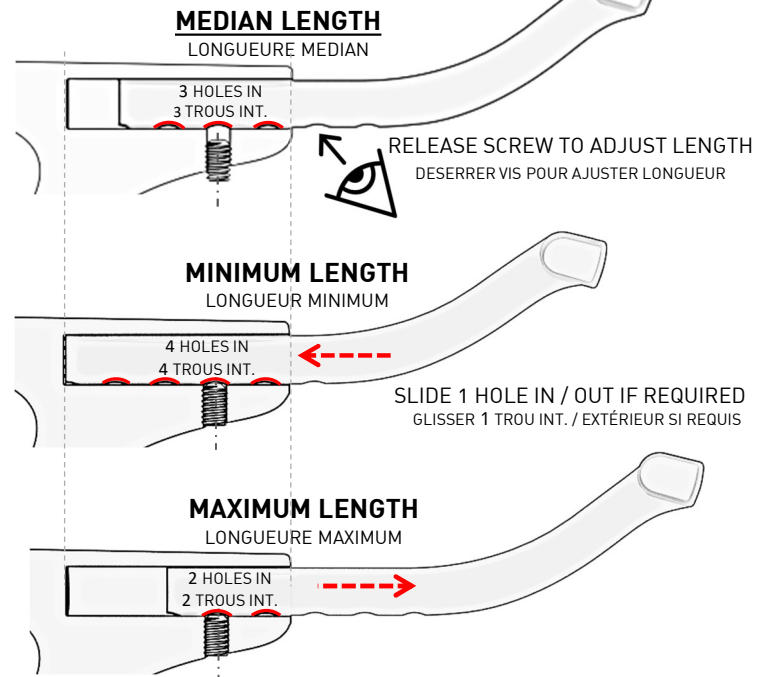

XTERN SUMMIT LARGE : 101100-SA-L

FULL SCALE CUTTING TEMPLATE
GABARIT COUPE VRAIE GRANDEUR

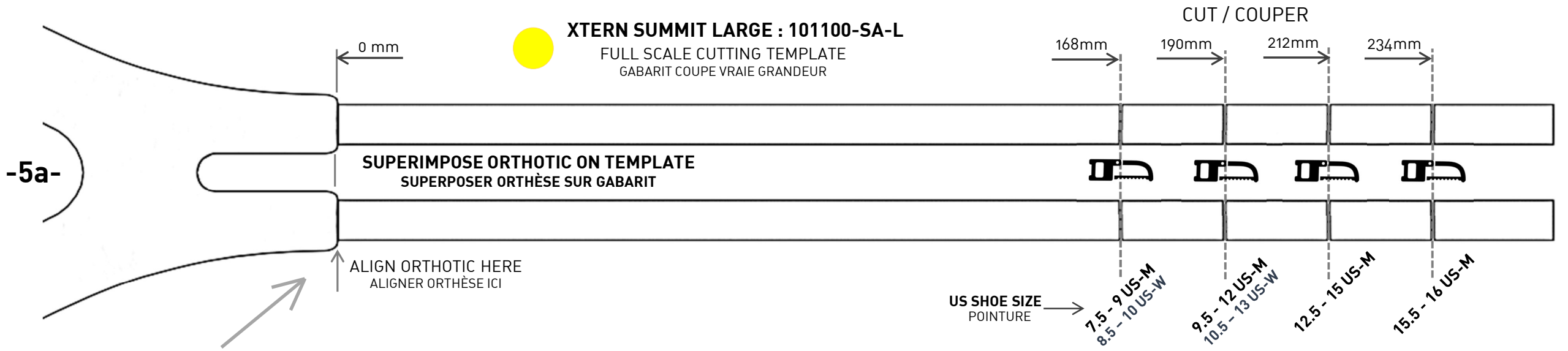

SEE CUTTING TEMPLATE
VOIR GABARIT DE COUPE

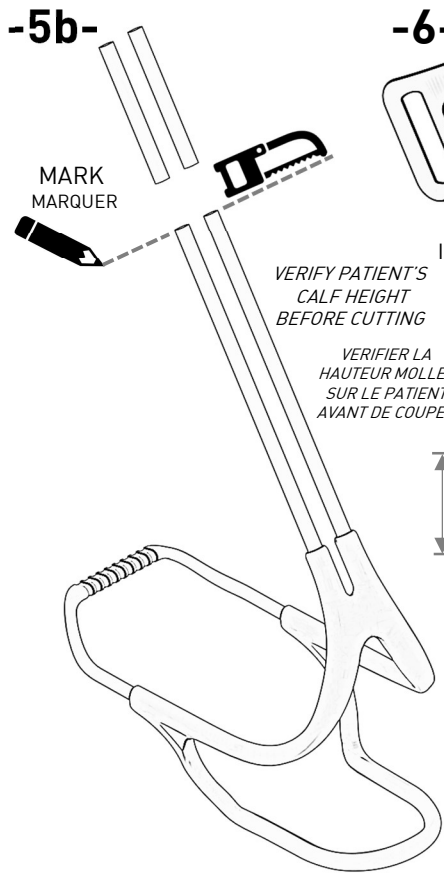

VERIFY PATIENT'S CALF HEIGHT BEFORE CUTTING
VERIFIER LA HAUTEUR MOLLET SUR LE PATIENT AVANT DE COUPER

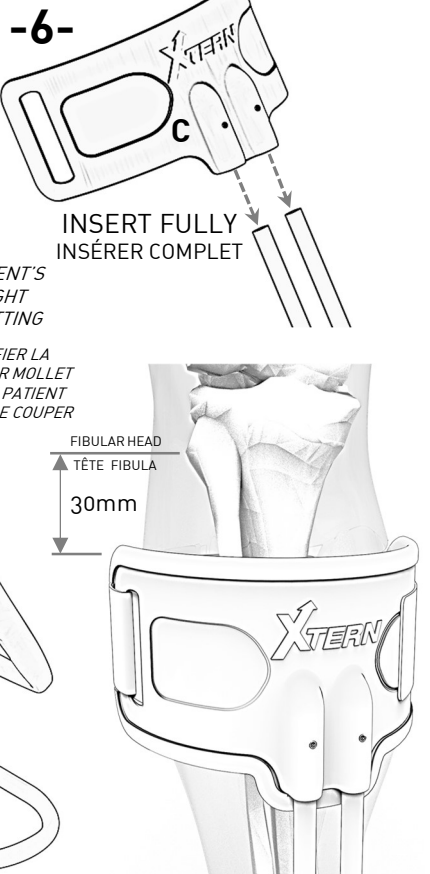

FIBULAR HEAD
TÊTE FIBULA
30mm

